

# 2A, 6.5V, Ultra Low Noise, Ultra Low Dropout Linear Regulator Evaluation Board Guidance

## ***General Description***

The Evaluation Board user guide describes the operational use of the RTQ2532N evaluation board as a reference design for demonstration and evaluation of the RTQ2532N, a high-current, ultra-low noise, ultra low-dropout (LDO) linear regulator.

Included in this user guide are setup and operating instructions, thermal and layout guidelines, a printed circuit board (PCB) layout, a schematic diagram, and a bill of materials (BOM). For more detail information, please refer to the RTQ2532N datasheet.

## **Table of Contents**

General Description .....	1
Performance Sepcification Summary .....	2
Power-up Procedure .....	2
Detailed Description of Hardware .....	3
Bill of Materials.....	5
Typical Applications .....	6
Evaluation Board Layout.....	10
More Information.....	10
Important Notice for Richtek Evaluation Board.....	12

## Performance Specification Summary

Summary of the RTQ2532N Evaluation Board performance specification is provided in Table 1. The ambient temperature is 25°C.

Table 1. RTQ2532N Evaluation Board Performance Specification Summary

Specification	Test Conditions	Min	Typ	Max	Unit
<b>Input Voltage Range</b>		1.1	1.1	6.5	V
<b>Output Current</b>		0	--	2	A
<b>Output Voltage Range</b>	Using external resistors	0.8	0.8	5.5	V
<b>Line Regulation</b>	$I_{OUT} = 1\text{mA}$ , $1.1\text{V} \leq V_{IN} \leq 6.5\text{V}$	--	0.05	--	%/V
<b>Load Regulation</b>	$1\text{mA} \leq I_{OUT} \leq 2\text{A}$	--	0.08	--	%/A
<b>Dropout Voltage</b>	$V_{IN} = 1.1\text{V}$ to $6.5\text{V}$ , $I_{OUT} = 2\text{A}$ , $V_{FB} = 0.8\text{V} - 3\%$	--	--	125	mV

## Power-up Procedure

### Suggestion Required Equipments

- RTQ2532N Evaluation Board
- DC power supply capable of at least 6.5V and 2A
- Electronic load capable of 2A
- Function Generator
- Oscilloscope

### Quick Start Procedures

The Evaluation Board is fully assembled and tested. Follow the steps below to verify board operation. Do not turn on supplies until all connections are made. When measuring the output voltage ripple, care must be taken to avoid a long ground lead on the oscilloscope probe. Measure the output voltage ripple by touching the probe tip and grounding directly across the last output capacitor.

### Proper measurement equipment setup and follow the procedure below.

- 1) With power off, connect the input power supply to VIN and GND pins.
- 2) With power off, connect the electronic load between the VOUT and nearest GND pins.
- 3) Turn on the power supply at the input. Make sure that the input voltage does not exceeds 6V on the Evaluation Board.
- 4) Check for the proper output voltage using a voltmeter.
- 5) Once the proper output voltage is established, adjust the load within the operating ranges and observe the output voltage regulation, quiescent current, dropout voltage, PSRR, noise and other performance.

## Detailed Description of Hardware

### Headers Description and Placement

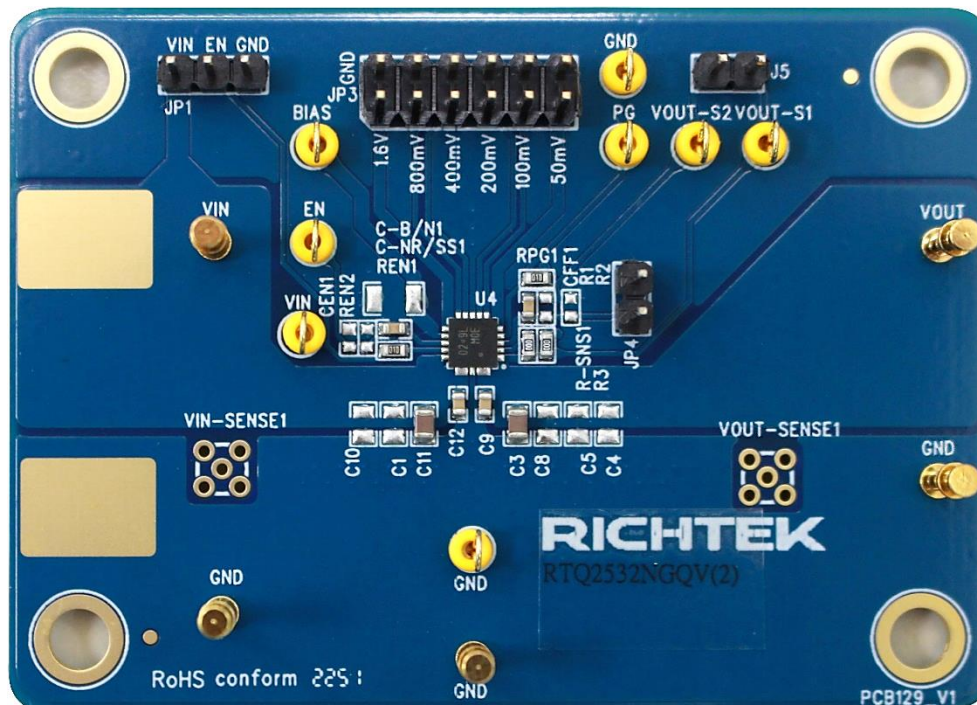

Carefully inspect all the components used in the EVB according to the following Bill of Materials table, and then make sure all the components are undamaged and correctly installed. If there is any missing or damaged component, which may occur during transportation, please contact our distributors or e-mail us at [evb\\_service@richtek.com](mailto:evb_service@richtek.com).

### Test Points

The EVB is provided with the test points and pin names listed in the table below.

Test Point/ Pin Name	Function
<b>VOUT</b>	Output of the regulator.
<b>VIN</b>	Supply input pin.
<b>BIAS</b>	Bias input pin.
<b>PG</b>	Power good sense pin.
<b>GND</b>	System ground pin.
<b>EN</b>	Enable sense pin.
<b>VOUT-S1/VOUT-S2</b>	Waveform sense pin for resistor R3.
<b>JP1</b>	User can decide EN pin connected to high or low.
<b>JP3</b>	Output voltage setting pin.

Test Point/ Pin Name	Function
<b>JP4</b>	Feedback voltage sense pin.
<b>J5</b>	Short to by-pass resistor R3.

**Bill of Materials**

VIN = 1.1V to 6.5V, VOUT = 0.8V to 5.5V, IOUT = 2A						
Reference	Count	Part Number	Value	Description	Package	Manufacturer
U1	1	RTQ2532NGQV(2)	RTQ2532N	LDO	VQFN-20L 3.5x3.5	RICHTEK
C-NR/SS1, CFF1	2	0603B103K500CT	10nF	Capacitor, ceramic, 50V, X7R	0603	WALSIN
C3, C11	2	GRM21BR61E226ME44L	22μF	Capacitor, ceramic, 25V, X5R	0805	MURATA
C9, C12	2	0603B104K500CT	0.1μF	Capacitor, ceramic, 50V, X7R	0603	WALSIN
R-SNS1, R3	2	WR06X000 PTL	0	Resistor, Chip	0603	WALSIN
REN1, RPG1	2	WR06X1003FTL	100k	Resistor, Chip	0603	WALSIN

## Typical Applications

### EVB Schematic Diagram

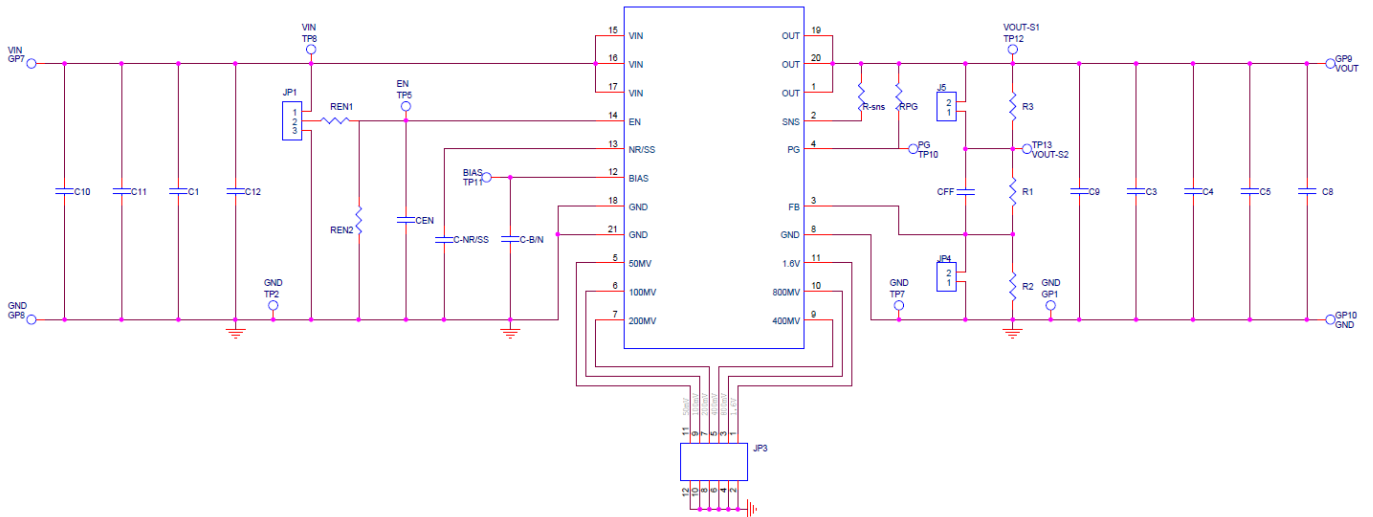

1. The capacitance values of the input and output capacitors will influence the input and output voltage ripple.
2. MLCC capacitors have degrading capacitance at DC bias voltage, and especially smaller size MLCC capacitors will have much lower capacitance.
3. V<sub>OUT</sub> select pin settings of JP3 please refer to Table 2.

Table 2. V<sub>OUT</sub> Select Pin Settings for Different Targets

V <sub>OUT</sub> (V)	50mV	100mV	200mV	400mV	800mV	1.6V	V <sub>OUT</sub> (V)	50mV	100mV	200mV	400mV	800mV	1.6V
0.8	Open	Open	Open	Open	Open	Open	2.4	Open	Open	Open	Open	Open	GND
0.85	GND	Open	Open	Open	Open	Open	2.45	GND	Open	Open	Open	Open	GND
0.9	Open	GND	Open	Open	Open	Open	2.5	Open	GND	Open	Open	Open	GND
0.95	GND	GND	Open	Open	Open	Open	2.55	GND	GND	Open	Open	Open	GND
1	Open	Open	GND	Open	Open	Open	2.6	Open	Open	GND	Open	Open	GND
1.05	GND	Open	GND	Open	Open	Open	2.65	GND	Open	GND	Open	Open	GND
1.1	Open	GND	GND	Open	Open	Open	2.7	Open	GND	GND	Open	Open	GND
1.15	GND	GND	GND	Open	Open	Open	2.75	GND	GND	GND	Open	Open	GND
1.2	Open	Open	Open	GND	Open	Open	2.8	Open	Open	Open	GND	Open	GND
1.25	GND	Open	Open	GND	Open	Open	2.85	GND	Open	Open	GND	Open	GND
1.3	Open	GND	Open	GND	Open	Open	2.9	Open	GND	Open	GND	Open	GND
1.35	GND	GND	Open	GND	Open	Open	2.95	GND	GND	Open	GND	Open	GND
1.4	Open	Open	GND	GND	Open	Open	3	Open	Open	GND	GND	Open	GND
1.45	GND	Open	GND	GND	Open	Open	3.05	GND	Open	GND	GND	Open	GND
1.5	Open	GND	GND	GND	Open	Open	3.1	Open	GND	GND	GND	Open	GND
1.55	GND	GND	GND	GND	Open	Open	3.15	GND	GND	GND	GND	Open	GND
1.6	Open	Open	Open	Open	GND	Open	3.2	Open	Open	Open	Open	GND	GND
1.65	GND	Open	Open	Open	GND	Open	3.25	GND	Open	Open	Open	GND	GND
1.7	Open	GND	Open	Open	GND	Open	3.3	Open	GND	Open	Open	GND	GND
1.75	GND	GND	Open	Open	GND	Open	3.35	GND	GND	Open	Open	GND	GND
1.8	Open	Open	GND	Open	GND	Open	3.4	Open	Open	GND	Open	GND	GND
1.85	GND	Open	GND	Open	GND	Open	3.45	GND	Open	GND	Open	GND	GND
1.9	Open	GND	GND	Open	GND	Open	3.5	Open	GND	GND	Open	GND	GND
1.95	GND	GND	GND	Open	GND	Open	3.55	GND	GND	GND	Open	GND	GND
2	Open	Open	Open	GND	GND	Open	3.6	Open	Open	Open	GND	GND	GND
2.05	GND	Open	Open	GND	GND	Open	3.65	GND	Open	Open	GND	GND	GND
2.1	Open	GND	Open	GND	GND	Open	3.7	Open	GND	Open	GND	GND	GND
2.15	GND	GND	Open	GND	GND	Open	3.75	GND	GND	Open	GND	GND	GND
2.2	Open	Open	GND	GND	GND	Open	3.8	Open	Open	GND	GND	GND	GND
2.25	GND	Open	GND	GND	GND	Open	3.85	GND	Open	GND	GND	GND	GND
2.3	Open	GND	GND	GND	GND	Open	3.9	Open	GND	GND	GND	GND	GND
2.35	GND	GND	GND	GND	GND	Open	3.95	GND	GND	GND	GND	GND	GND

Measure Result

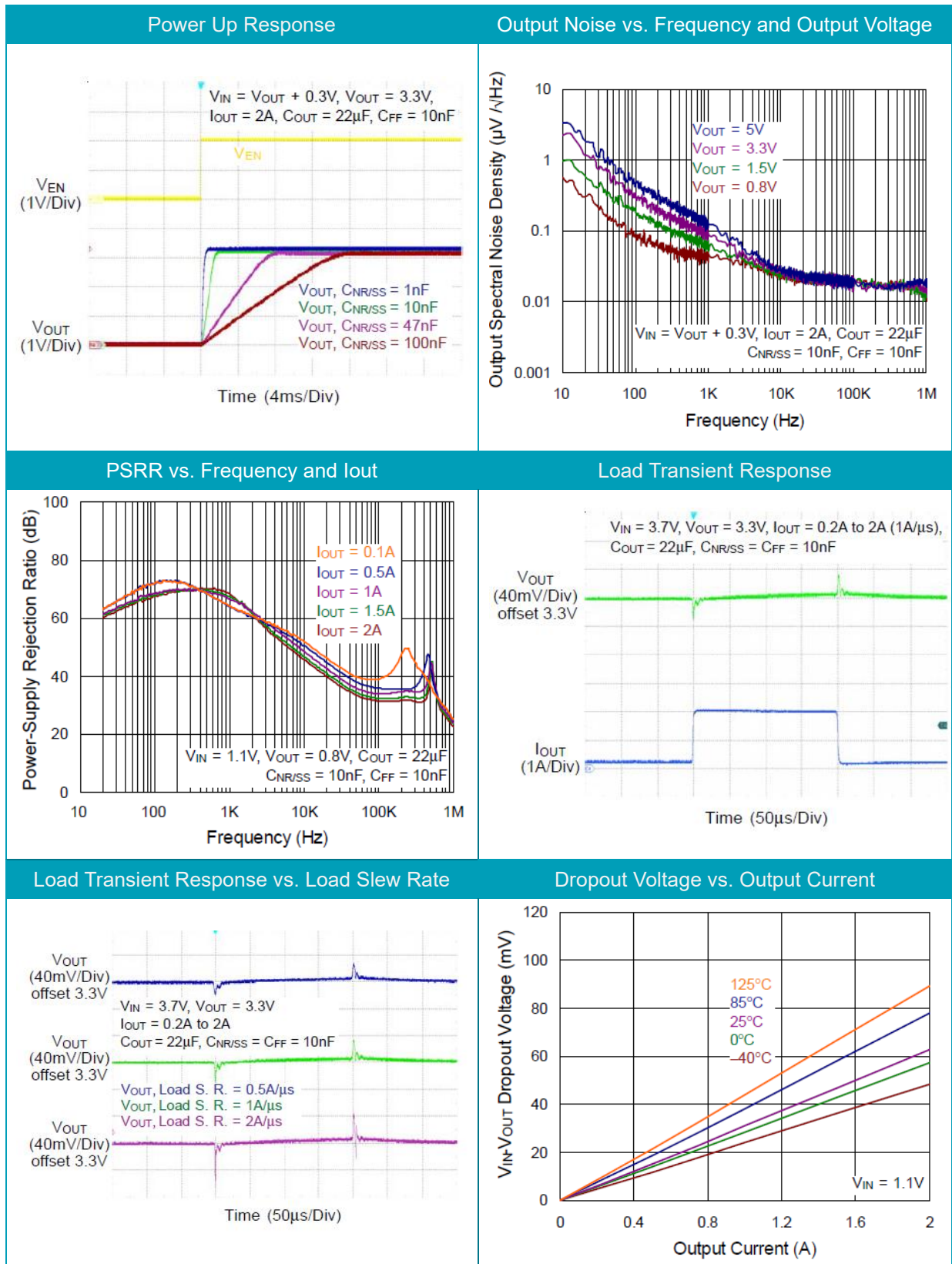



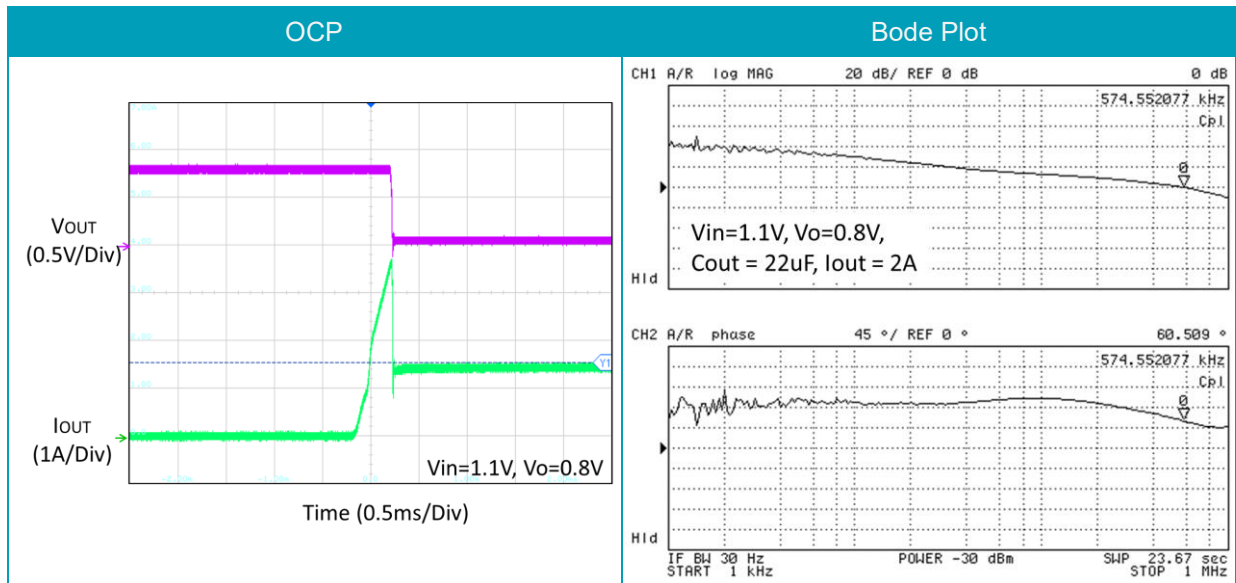

Note: When measuring the input or output voltage ripple, care must be taken to avoid a long ground lead on the oscilloscope probe. Measure the output voltage ripple by touching the probe tip directly across the output capacitor.

**Evaluation Board Layout**

Figure 1 to Figure 4 are RTQ2532N Evaluation Board layout. This board is constructed on four-layer PCB, outer layers with 1 oz. Cu and inner layers with 1 oz. Cu.

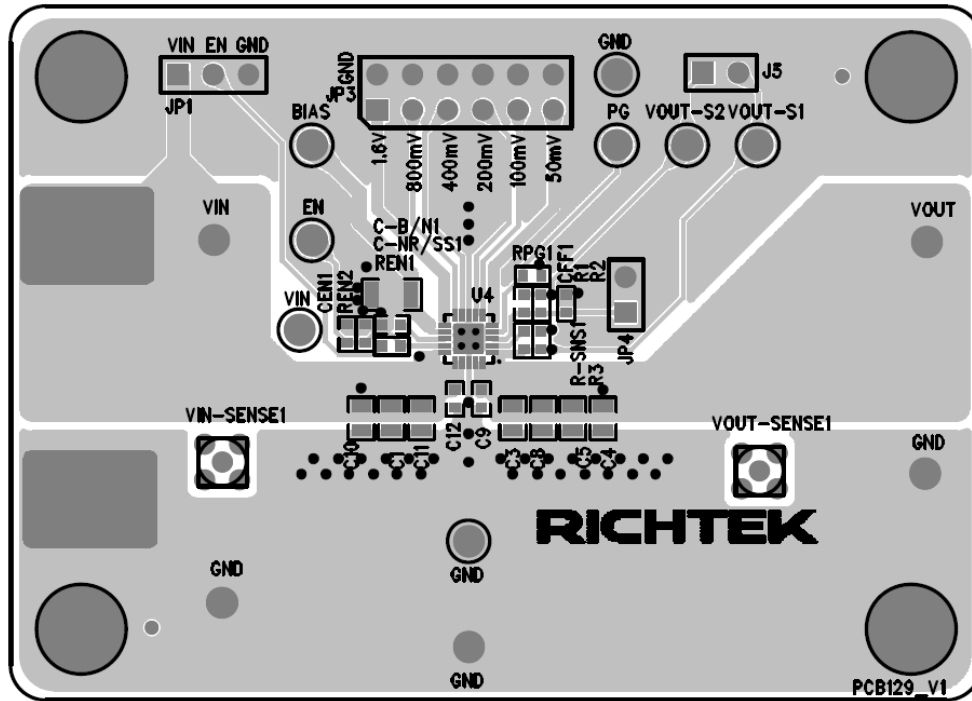

Figure 1. Top View (1<sup>st</sup> layer)

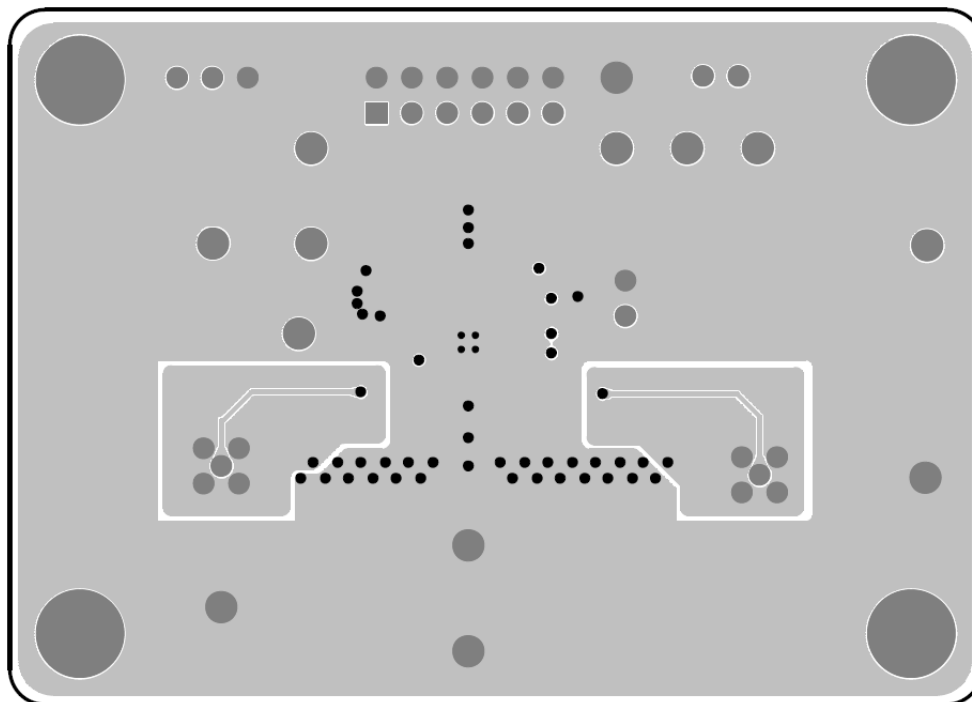

Figure 2. PCB Layout—Inner Side (2<sup>nd</sup> Layer)

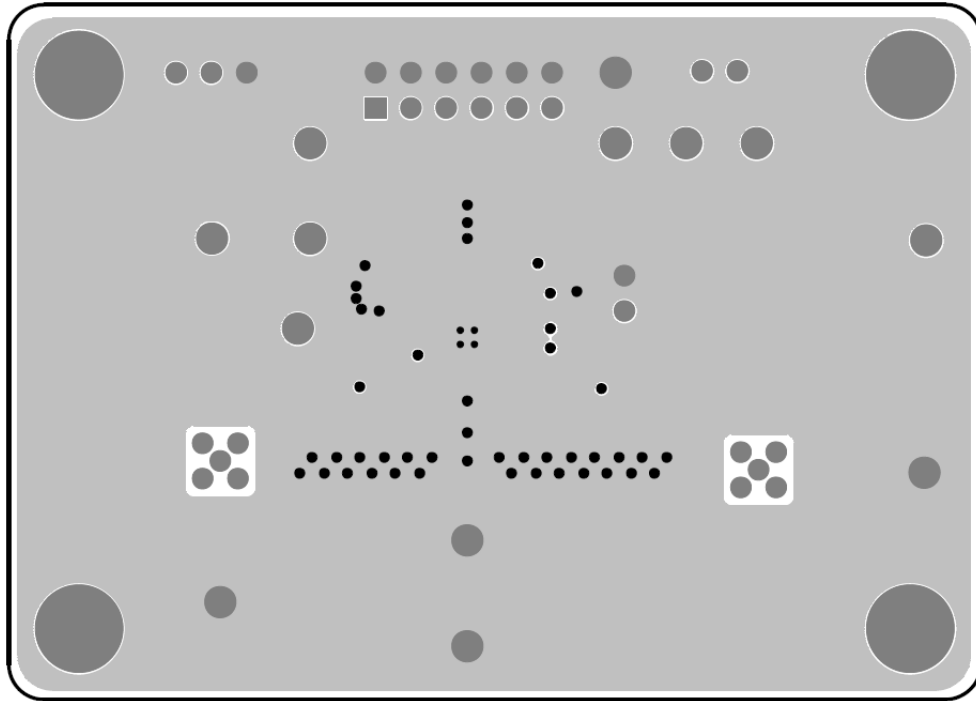

Figure 3. PCB Layout—Inner Side (3<sup>rd</sup> Layer)

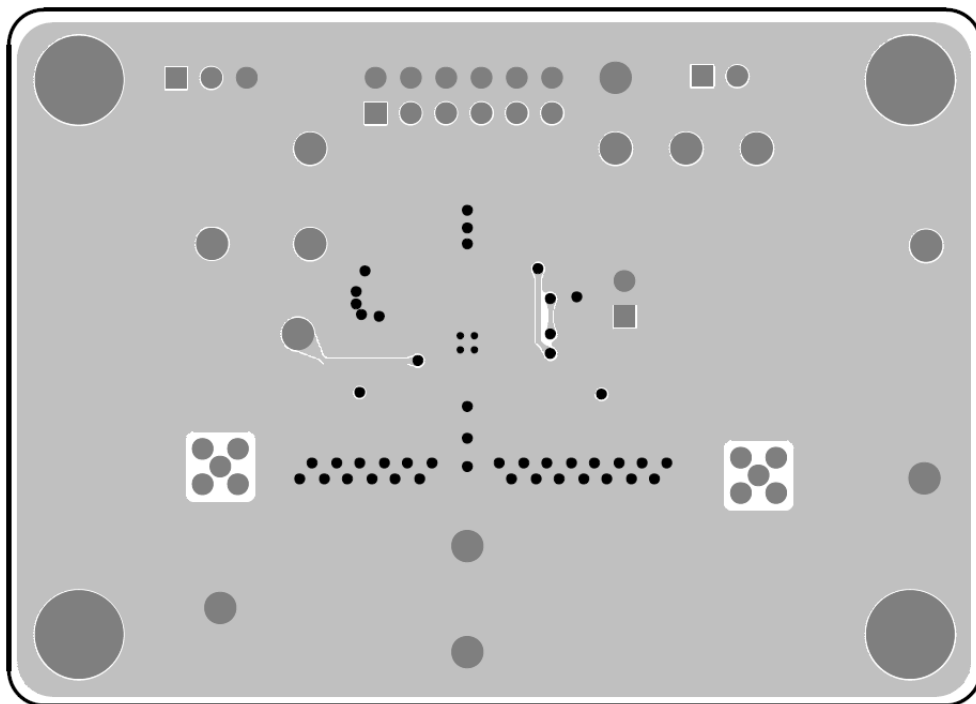

Figure 4. Bottom View (4<sup>th</sup> Layer)

### ***More Information***

For more information, please find the related datasheet or application notes from Richtek website  
<http://www.richtek.com>.

### ***Important Notice for Richtek Evaluation Board***

THIS DOCUMENT IS FOR REFERENCE ONLY, NOTHING CONTAINED IN THIS DOCUMENT SHALL BE CONSTRUED AS RICHTEK'S WARRANTY, EXPRESS OR IMPLIED, UNDER CONTRACT, TORT OR STATUTORY, WITH RESPECT TO THE PRESENTATION HEREIN. IN NO EVENT SHALL RICHTEK BE LIABLE TO BUYER OR USER FOR ANY AND ALL DAMAGES INCLUDING WITHOUT LIMITATION TO DIRECT, INDIRECT, SPECIAL, PUNITIVE OR CONSEQUENTIAL DAMAGES.